

# J-Flash

User guide of the stand-alone  
flash programming software

Document: UM08003  
Software Version: 6.32  
Revision: 3  
Date: April 18, 2019



A product of SEGGER Microcontroller GmbH

[www.segger.com](http://www.segger.com)

## Disclaimer

Specifications written in this document are believed to be accurate, but are not guaranteed to be entirely free of error. The information in this manual is subject to change for functional or performance improvements without notice. Please make sure your manual is the latest edition. While the information herein is assumed to be accurate, SEGGER Microcontroller GmbH (SEGGER) assumes no responsibility for any errors or omissions. SEGGER makes and you receive no warranties or conditions, express, implied, statutory or in any communication with you. SEGGER specifically disclaims any implied warranty of merchantability or fitness for a particular purpose.

## Copyright notice

You may not extract portions of this manual or modify the PDF file in any way without the prior written permission of SEGGER. The software described in this document is furnished under a license and may only be used or copied in accordance with the terms of such a license.

© 2004-2018 SEGGER Microcontroller GmbH, Monheim am Rhein / Germany

## Trademarks

Names mentioned in this manual may be trademarks of their respective companies.

Brand and product names are trademarks or registered trademarks of their respective holders.

## Contact address

SEGGER Microcontroller GmbH

Ecolab-Allee 5  
D-40789 Monheim am Rhein

Germany

Tel.           +49-2173-99312-0  
Fax.           +49-2173-99312-28  
E-mail:       support@segger.com  
Internet:     www.segger.com

## Manual versions

This manual describes the current software version. If you find an error in the manual or a problem in the software, please report it to us and we will try to assist you as soon as possible.

Contact us for further information on topics or functions that are not yet documented.

Print date: April 18, 2019

Manual version	Revision	Date	By	Description
6.32	4	190418	FF	Chapter "Getting Started" * Section "Menu structure": added a note in the table "Target menu elements" for Manual Programming > Program.
6.32	3	190327	MF	Chapter "Settings" * Section "Production setting": added clarification note for target power supply.
6.32	2	180621	LG	Chapter "Command Line Interface" * Section "Command line options": Added new CL option -setcpuidcode.
6.32	1	180427	LG	Chapter "Command Line Interface" * Section "Command line options": Added new CL option -saveas. * Section "Command line options": Updated CL option -merge. * Section "Command line options": Updated CL option -setrxidcode.
6.30	2	180417	NV	Screenshots updated. Chapter "Command Line Interface" * Section "Command line options": Added new CL option -hide. * Section "Command line options": Updated CL option -jflashlog. * Section "Command line options": Updated CL option -jlinklog.
6.30	1	180216	LG	Screenshots updated. Chapter "Settings" * Added section "Performance settings"
5.02c	0	150914	RH	Chapter "Command Line Interface" * Section "Command line options" Added new commands: -verifycra, verifycrs and verifycrrc
5.02a	0	150907	EL	Chapter "Command Line Interface" * Section "Command line options" updated.
5.00c	0	150611	EL	Chapter "Command Line Interface" * Section "Programming multiple targets in parallel" updated.
4.98	2	150427	EL	Chapter "Command Line Interface" * Section "Command line options" Added new command: -ip and -USB.
4.98	1	150320	AG	Chapter "Background information" * Section "CRC of current data file" Polynomial corrected.
4.98	0	150113	NG	Chapter "Command Line Interface" Changed "JFlashARM.exe" to "JFlash.exe".
4.96	0	150109	EL	Chapter "Device specifics" * Section "ST" updated. * Section "Freescall" updated.
4.82	0	140307	AG	Chapter "Device specifics" * Section "ST" updated.
4.80	0	131220	AG	Chapter "Command Line Interface" * Section "Command line options" updated.
4.73c	0	130703	JL	Chapter "Getting Started" * Added Section "Start Dialog"
4.66	1	130320	EL	Chapter "Settings" * Section "CPU Settings" Added description for the core ID "Mask" field
4.66	0	130221	JL	Chapter "Introduction" * Section "What is J-Flash" Added Linux and Mac OSX
4.58	0	121113	JL	Chapter "Command Line Interface" * Section "Batch processing" updated. * Section "Command line options" updated.

Manual version	Revision	Date	By	Description
4.52	0	120807	EL	Chapter "Getting Started" * Section "Menu structure" updated Chapter "Settings" * Section "CPU Settings" updated Chapter "Command Line Interface" * Section "Programming multiple targets in parallel" added. Chapter "Getting Started" * Section "Sample Projects" updated.
4.51i	0	120724	EL	Chapter "Create a new J-Flash project" * Section "Configuration for serial number programming" added.
4.42b	0	120217	AG	Chapter "Background information" * Section "CRC of current data file" added.
4.24	0	110216	AG	Chapter "Target systems" updated.
4.16	1	100817	AG	Chapter "Command Line Interface" * Section "Command line options" corrected.
4.16	0	100723	KN	Chapter "Settings" * Section "Init sequence" updated.
4.10	4	091204	AG	Chapter "Device specifics" * Section "Freescale" added.
4.10	2	090918	AG	Chapter "Command Line interface" * Section "Command line options" updated.
4.10	1	090902	AG	Chapter "Device specifics" * Section "ST Microelectronics" updated.
4.10	0	090825	AG	Chapter "Device specifics" * Section "ST Microelectronics" updated.
4.04	1	090414	AG	Chapter "Introduction" * Section "What is J-Flash?" updated.
4.04	0	090204	AG	Chapter "Command Line Interface" * Section "Overview" updated. * Section "Command Line Options" updated.
3.97e	0	081204	KN	Chapter "Target systems" * Section "Supported Flash Devices" updated Chapter "Settings" * Section "Init sequence" corrected
3.91n	0	080923	AG	Chapter "Working with J-Flash" renamed to "Create a new J-Flash project." Chapter "Create a new J-Flash project" Chapter "Settings" * Section "Init sequence" updated. Chapter "Command Line Interface" updated. * Section "Create a new J-Flash project" updated.
3.90	0	080811	AG	Chapter "Targets" * Section "Supported Microcontrollers" updated.
3.80	2	080408	AG	Chapter "Licensing" * Section "Introduction" added. * Section "License types" added.
3.80	1	080311	AG	Chapter "Target systems" * Section "Supported Microcontrollers" updated. Chapter "Working with J-Flash" * Section "Create a new J-Flash project" updated.
3.80	0	080206	SK	Chapter "Device specifics" added. Chapter "Target systems" * Section supported MCUs updated.
3.68	1	070508	SK	Chapter "Installation" updated. Chapter "Command Line Interface": * Section "Batch processing" added. Various improvements.
3.66	1	070322	SK	Chapter "Target systems" updated. Chapter "Getting started" updated.
3.46	4	061222	SK	Section "About" and company description added.
3.46	3	061124	OO	Chapter "Performance" updated.

<b>Manual version</b>	<b>Revision</b>	<b>Date</b>	<b>By</b>	<b>Description</b>
3.46	2	061121	OO	Chapter "Performance" updated.
3.46	1	060929	TQ	Update supported target devices.
3.42	1	060912	TQ	Update supported target devices.
3.36	1	060801	TQ	Update supported target devices.
3.24	1	060530	TQ	Update supported target devices.
3.00	2	060116	OO	Screenshots updated.
3.00	1	060112	TQ	Nothing changed. Just a new software version.
2.14	0	051025	TQ	Update supported target devices.
2.10	0	050926	TW	Added troubleshooting section.
2.04	0	050819	TQ	Nothing changed. Just a new software version.
2.02	0	050808	TW	Command line added.
2.00	0	050707	TW	Initial Version



# About this document

---

## Assumptions

This document assumes that you already have a solid knowledge of the following:

- The software tools used for building your application (assembler, linker, C compiler).
- The C programming language.
- The target processor.
- DOS command line.

If you feel that your knowledge of C is not sufficient, we recommend *The C Programming Language* by Kernighan and Richie (ISBN 0-13-1103628), which describes the standard in C programming and, in newer editions, also covers the ANSI C standard.

## How to use this manual

This manual explains all the functions and macros that the product offers. It assumes you have a working knowledge of the C language. Knowledge of assembly programming is not required.

## Typographic conventions for syntax

This manual uses the following typographic conventions:

Style	Used for
Body	Body text.
Keyword	Text that you enter at the command prompt or that appears on the display (that is system functions, file- or pathnames).
Parameter	Parameters in API functions.
Sample	Sample code in program examples.
Sample comment	Comments in program examples.
Reference	Reference to chapters, sections, tables and figures or other documents.
GUIElement	Buttons, dialog boxes, menu names, menu commands.
Emphasis	Very important sections.





# Table of contents

---

1	Introduction .....	11
1.1	What is J-Flash? .....	12
1.1.1	Supported Operating Systems .....	12
1.1.2	Features .....	12
1.2	Assumptions .....	13
1.3	Requirements .....	14
2	Licensing .....	15
3	Getting Started .....	16
3.1	Setup .....	17
3.1.1	What is included? .....	17
3.2	Using J-Flash for the first time .....	18
3.2.1	Welcome dialog .....	18
3.2.2	Sample Projects .....	18
3.2.3	Creating a new J-Flash project .....	18
3.2.4	Creating a new init sequence .....	19
3.2.5	Serial number programming .....	21
3.3	Menu structure .....	25
4	Settings .....	28
4.1	Project Settings .....	29
4.1.1	General Settings .....	29
4.1.2	Target Interface Settings .....	29
4.1.3	MCU Settings .....	31
4.1.4	Flash Settings .....	35
4.1.5	Production settings .....	38
4.1.6	Performance settings .....	40
4.2	Global Settings .....	41
5	Command Line Interface .....	42
5.1	Overview .....	43
5.2	Command line options .....	44
5.3	Batch processing .....	46
5.4	Programming multiple targets in parallel .....	47

6	Device specifics .....	48
7	Target systems .....	49
7.1	Which devices can be programmed by J-Flash? .....	50
7.2	Supported microcontrollers .....	51
7.2.1	Supported Flash Devices .....	51
8	Performance .....	52
9	Background information .....	53
9.1	CRC of current data file .....	54
10	Support .....	55
10.1	Troubleshooting .....	56
10.1.1	General procedure .....	56
10.1.2	Typical problems .....	56
10.2	Contacting support .....	58

# Chapter 1

## Introduction

---

The following chapter introduces J-Flash, highlights some of its features, and lists its requirements on host and target systems.

## 1.1 What is J-Flash?

J-Flash is a stand-alone flash programming software for PCs running Microsoft Windows.

J-Flash has an intuitive user interface and makes programming flash devices convenient. J-Flash requires a J-Link / Flasher, JTAG emulator for ARM cores, to interface to the hardware. It is able to program internal and external flash at very high speeds, upwards of 550 KBytes/s depending on the chip. Another notable feature is smart read back, which only transfers non-blank portions of the flash, increasing the speed of read back greatly. These features along with its ability to work with any ARM7 or ARM9 chip makes it a great solution for most projects.

### 1.1.1 Supported Operating Systems

The following Microsoft Windows versions are supported:

- Microsoft Windows 2000
- Microsoft Windows XP
- Microsoft Windows XP x64
- Microsoft Windows 2003
- Microsoft Windows 2003 x64
- Microsoft Windows Vista
- Microsoft Windows Vista x64
- Microsoft Windows 7
- Microsoft Windows 7 x64
- Microsoft Windows 8
- Microsoft Windows 8 x64
- Microsoft Windows 10
- Microsoft Windows 10 x64

### 1.1.2 Features

- Any ARM7/ARM9/ARM11, Cortex-M0/M1/M3/M4/M7, Cortex-A5/A8/A9/R4/R5 and Renesas RX600 core supported
- Microcontroller (internal flash) support.
- Support for most external flash chips (For more information please refer to *Target systems* on page 49).
- High speed programming: up to 550 KBytes/s\* (depending on flash device).
- Smart read back: only non-blank portions of flash are transferred and saved.
- Free evaluation licenses available.
- Verbose logging of all communication.
- .hex, .mot, .srec, and .bin support.
- Intuitive user interface.

\* = Measured with J-Link V10

## 1.2 Assumptions

This user manual assumes that you already possess working knowledge of the J-Link device. If you feel that your knowledge of J-Link is not sufficient, we recommend the J-Link Manual (UM08001), which describes the device and its use in detail.

## 1.3 Requirements

- J-Link / Flasher
- Supported operating system (see *Supported Operating Systems* on page 12)
- Interface from Host to probe (USB, Ethernet,...)
- Supported device/core (see *Supported microcontrollers* on page 51)

# Chapter 2

## Licensing

---

J-Flash may be installed on as many host machines as you want. Without a license key J-Flash can still be used to open project files, read from connected devices, blank check target memory, verify data files and so on. However to actually program devices via J-Flash and J-Link, a valid license is required. For an overview which SEGGER products come with a build-in license for J-Flash, please refer to the [J-Link Model overview](#) . All Flasher models come with a build-in license for J-Flash.

# Chapter 3

## Getting Started

---

This chapter presents an introduction to J-Flash. It provides an overview of the included sample projects and describes J-Flash's menu structure in detail.



## 3.1 Setup

The J-Link setup procedure required in order to work with the J-Flash is described in chapter 2 of the J-Link / J-Trace User Guide (UM08001). The J-Link / J-Trace User Guide (UM08001) is part of the J-Link Software and Documentation Pack which is available for download under <https://www.segger.com/jlink-software.html>.

### 3.1.1 What is included?

The following table shows the contents of all subdirectories of the J-Link Software and Documentation Pack with regard to J-Flash:

Directory	Contents
.	The J-Flash application. Please refer to the J-Link Manual (UM08001) for more information about the other J-Link related tools.
.\Doc	Contains the J-Flash documentation and the other J-Link related manuals.
.\ETC\JFlash	Two *.csv files for the J-Flash internal management of supported MCU's und flash chips.
.\Samples\JFlash \ProjectFiles	Contains sample projects with good default settings (see section <i>Sample Projects</i> on page 18 for further details).

## 3.2 Using J-Flash for the first time

### 3.2.1 Welcome dialog

When starting J-Flash, by default a startup dialog pops up which gives the user two options how to proceed.

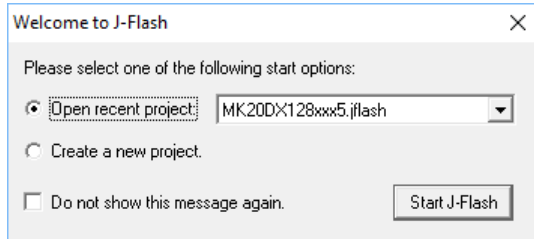

*Welcome Dialog*

The startup dialog provides the following options:

- **Open existing project:** Select a project from the list of recent projects or select "Other.." to open another existing project.
- **Create new project:** Creates a blank/empty project with J-Flash default settings.

If "Do not show this message again." is checked, J-Flash will execute the option currently selected automatically on future starts without showing the welcome dialog again.

### 3.2.2 Sample Projects

For some setups, special settings / configurations needs to be done in the J-Flash project (e.g. PLL initialization, external bus interface initialization, script files, etc...). Therefore, the J-Link Software and Documentation Pack already includes some example project for various special setups which can be used as reference for custom setups.

Those project files can be found in the \Samples\JFlash\ProjectFiles subdirectory of the J-Link Software and Documentation Pack installation directory.

### 3.2.3 Creating a new J-Flash project

The recommend way of getting started with J-Flash is to use the create new project wizard.

- Start by selecting the **Create new project** of the Welcome dialog or by selecting **File** -> **New project**
- The new project wizard will launch, which looks like as follows:

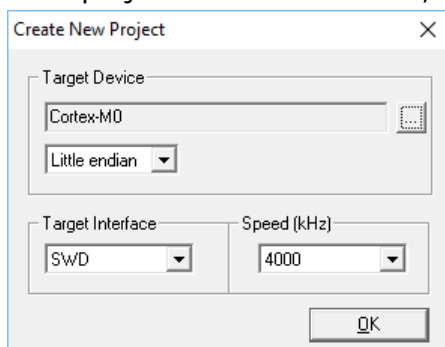

*New project wizard*

- Select the target device, the target interface and interface speed according to the setup. If only a core is selected, the target endianness must be specified.
- Click **OK**

The created Project file is now ready for use. More sophisticated settings can be configured in the **Project settings**. Please refer to *Project Settings* on page 29.

## 3.2.4 Creating a new init sequence

Many microcontrollers require a custom init sequence to initialize the target hardware, for example the initialize the PLL, disable the watchdog or define the wait states of the flash. This means that an compatible init sequence for the microcontroller must be built, if a new project is created or one of the existing projects is modified.

A custom init sequence can be built or updated in the **MCU** tab of the **Project settings** menu. Click the **Add** button to open the **Add action** dialog.

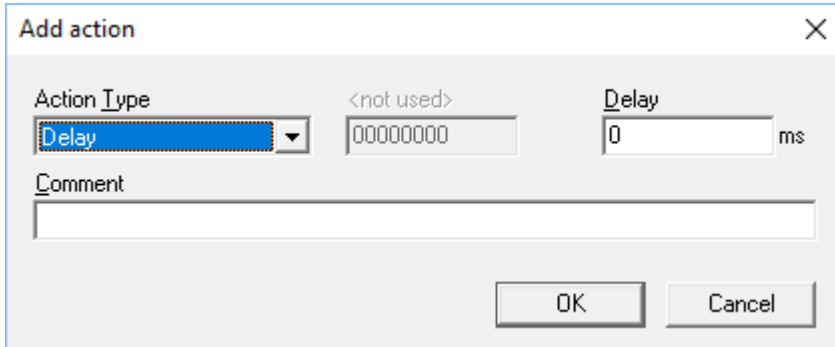

The screenshot shows a dialog box titled "Add action" with a close button (X) in the top right corner. The dialog contains the following elements:

- Action Type:** A dropdown menu with "Delay" selected.
- Parameter:** A text box containing "<not used>" and another text box containing "00000000".
- Delay:** A text box containing "0" followed by "ms".
- Comment:** A large empty text box.
- Buttons:** "OK" and "Cancel" buttons at the bottom.

*Init Steps: Add action dialog*

In the **Action Type** choice-list all possible commands are listed. The following two text boxes are dependent on the chosen command. They are grayed out or used to enter the required parameter. The **Comment** text box should be used to enter a short description of the action. For a list of all valid commands which can be used in an init sequence, please refer to *Init steps* on page 32.

### 3.2.4.1 Example init sequence

A good example of a typical init sequence is the init sequence of an AT91SAM7 CPU. The following example is excerpted from the J-Flash project for the AT91SAM7S256.

#### The example init sequence step by step

0. Reset the target with J-Link reset strategy 0 and 0 delay.
1. Disable the watchdog by writing to the Watchdog Timer Mode Register.
2. Set flash wait states by writing to the MC Flash Mode Register.
3. Set the PLL by writing to power management controller.
4. Set a delay of 200ms.
5. Set the PLL and the divider by writing to PLL Register of the power management controller.
6. Set a delay of 200ms.
7. Set the master and processor clock by writing to the Master Clock Register of the power management controller.

The steps implemented in J-Flash:

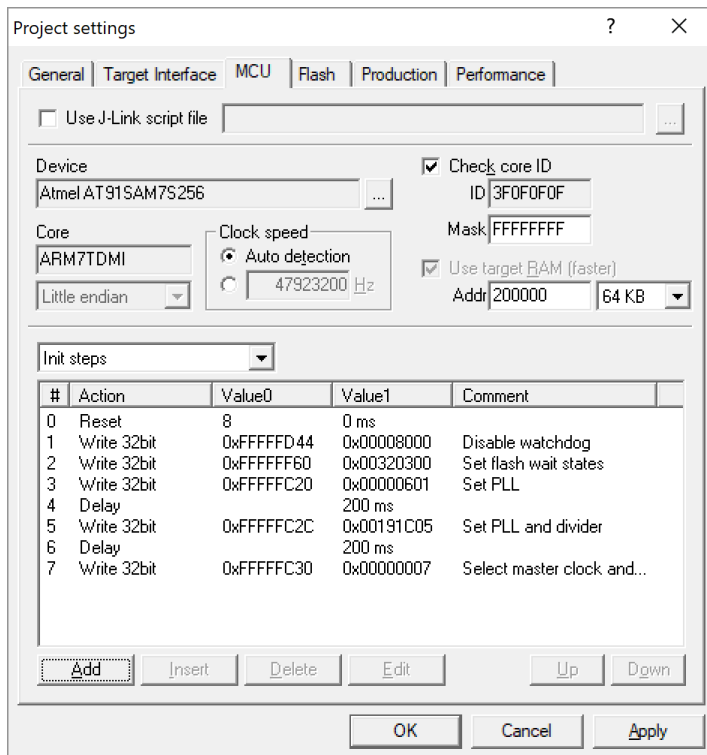

MCU settings: Init Steps: Example

### 3.2.5 Serial number programming

J-Flash supports programming of serial numbers. In order to use the serial number programming feature, the J-Flash project to be used as well as some files in the working folder (depending on the configuration) need to be configured first.

In general, J-Flash supports two ways of programming a serial number into the target:

1. Programming continuous serial numbers. Serial number is 1-4 bytes in size. Start serial number, increment, serial number size and address have to be configured in the J-Flash project production settings.
2. Programming custom serial numbers from a serial number list file. Start line into serial number list file to get next serial number bytes, line increment, serial number size and address is configured in J-Flash production project settings. Serial number list file needs to be specified and created by user.

In the following, some generic information how to setup a serial number programming configuration are given.

#### 3.2.5.1 Serial number settings

In order to use the serial number feature, the J-Flash project has to be configured to enable programming a serial number at a specific address. This is done by enabling the **Program serial number** option as shown in the screenshot and table below:

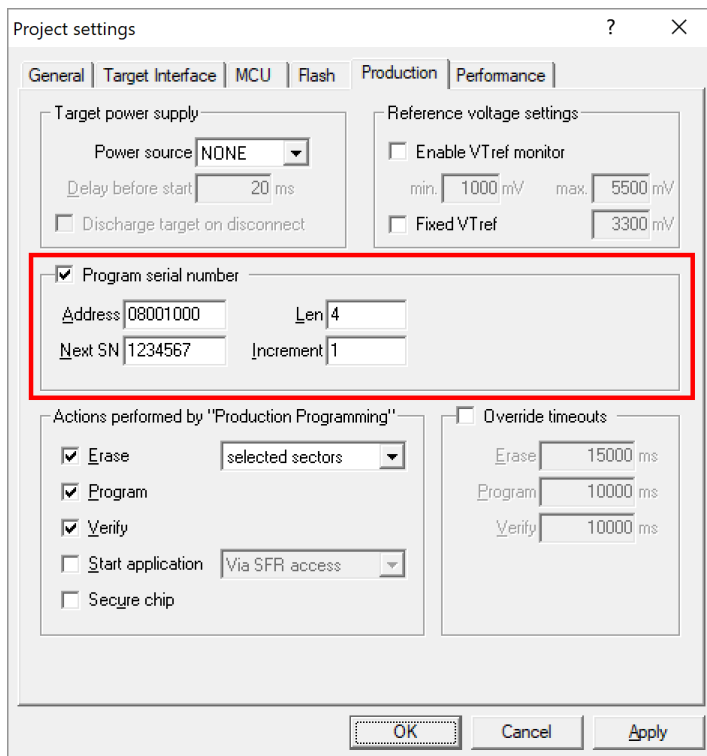

Program serial number option

Setting	Meaning
Address	The address the serial number should be programmed at.
Len	<p>The length of the serial number (in bytes) which should be programmed.</p> <ul style="list-style-type: none"> <li>• If no serial number list file is given, J-Flash allows to use a 1-4 byte serial number. In case of 8 is selected as length, the serial number and its complementary is programmed at the given address.</li> <li>• In case a serial number list file is given, J-Flash will take the serial number bytes from the list file. If a serial number in the list file does not define all bytes of <b>Len</b>, the remaining bytes are filled with 0s. No complements etc. are added to the serial number.</li> </ul>

Setting	Meaning
Next SN	<ul style="list-style-type: none"> <li>In case no serial number list file is given, <b>Next SN</b> is next serial number which should be programmed. The serial number is always stored in little endian format in the flash memory.</li> <li>In case a serial number list file is given, <b>Next SN</b> describes the line of the serial number list file where to read the next serial number bytes from. J-Flash starts counting with line 0, so in order to start serial number programming with the first line of the SNList.txt, <b>Next SN</b> needs to be set to 0.</li> </ul>
Increment	Specifies how much <b>Next SN</b> is incremented.

### 3.2.5.2 Serial number file

When starting the program process **Target -> Auto**, J-Flash will create a serial number file named as <JFlashProjectName>\_Serial.txt. The file is generated based on the serial number settings in the J-Flash project and will contain the value defined by the **Next SN** option. The serial number file can also be manually edited by the user, since the serial number is written ASCII.

### 3.2.5.3 Serial number list file

In order to program custom serial numbers which can not be covered by the standard serial number scheme provided by J-Flash (e.g. when programming non-continuous serial numbers or having gaps between the serial numbers), a so called serial number list file needs to be created by the user.

When selecting **Target -> Auto**, J-Flash will check for a serial number list file named as <JFlashProjectName>\_SNList.txt in the directory where the J-Flash project is located. The serial number list file needs to be created manually by the user and has the following syntax:

- One serial number per line
- Each byte of the serial number is described by two hexadecimal digits.

#### Example

A 8-byte serial number should be programmed at address 0x08000000. It should be programmed as follows in the memory:

```
0x08000000: 0x01 0x02 0x03 0x04 0x55 0x66 0x77 0x88
```

The serial number list file should look as follows:

```
0102030455667788
```

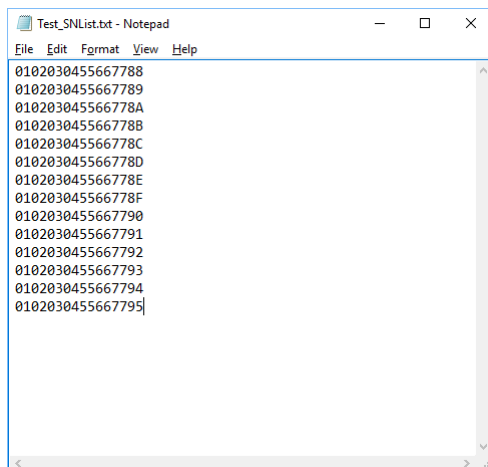

SN list example

The number of bytes to read per line is configured via the **Len** option in J-Flash. For more information, please refer to *Serial number settings* on page 21.

Which line J-Flash will read at the next programming cycle, is configured via the [Next SN](#) option in J-Flash. For more information, please refer to *Serial number settings* on page 21. In this case Next SN needs to be set to 0, since programming should be started with the serial number bytes defined in the first line of the file.

**Note**

If the number of bytes specified in a line of the serial number list file is less than the serial number length defined in the project, the remaining bytes filled with 0s by Flasher ARM.

**Note**

If the number of bytes specified in a line of the serial number list file is greater than the serial number length defined in the J-Flash project, the remaining bytes will be ignored by J-Flash

**Note**

When using Windows 7, please make sure that the used project file is located at a folder with write permission.

### 3.2.5.4 Programming process

J-Flash will increment the serial number in `<JFlashProjectName>_Serial.txt` by the value defined in [Increment](#), after each successful programming cycle.

### 3.2.5.5 Sample setup

In the following a small sample is given how to setup J-Flash for serial number programming. In the following sample, 4-byte serial numbers starting at 1234567 (0x12D687) shall be programmed at address 0x08001000.

#### Defining serial number address, length, start value and increment

In the J-Flash project the following needs to be defined:

- [Address](#) is 0x08001000
- [Len](#) is 4 (bytes)
- [Next SN](#) is 1234567
- [Increment](#) is 1

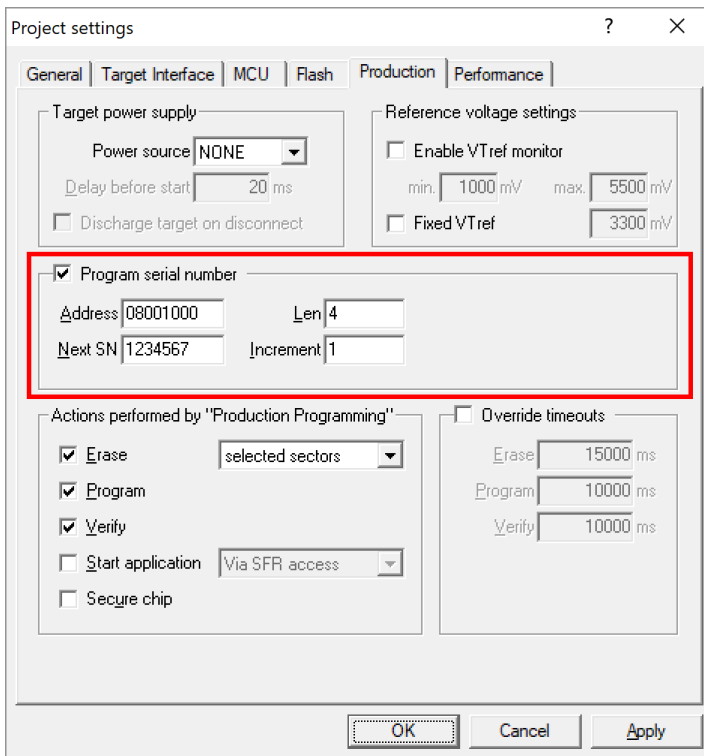

### *Program serial number option*

Now J-Flash is prepared to program the 8-byte serial number. After programming the serial number, J-Flash creates the <JFlashProjectName>\_Serial.txt.

Name	Date modified	Type	Size
STM32ZE_Test_jflash	2017-04-07 16:12	JFLASH File	3 KB
STM32ZE_Test_Serial.txt	2017-04-07 16:07	TXT File	1 KB
Test.mot	2017-04-07 16:10	MOT File	2 KB

### *Serial number file*



### 3.3 Menu structure

The main window of J-Flash contains seven dropdown menus (**File**, **Edit**, **View**, **Target**, **Options**, **Window**, **Help**). Any option within these dropdown menus that is followed by a three period ellipsis (...), is an option that requires more information before proceeding.

#### File menu elements

Command	Description
Open data file...	Opens a data file that may be used to flash the target device. The data file must be one of the following: Intel HEX file, Motorola S file, or Binary file (.hex, .mot, .srec, or .bin).
Merge data file...	<p>Merges two data files (.hex, .mot, .srec, or .bin). All gaps will be filled with FF. Find below a short example of merging two data files named, File0.bin and File1.bin into File3.bin.</p> <p>File0.bin -&gt; Addr 0x0200 - 0x02FF File1.bin -&gt; Addr 0x1000 - 0x13FF</p> <p>Merge File0.bin &amp; File1.bin 0x0200 - 0x02FF Data of File0.bin 0x0300 - 0x0FFF gap (will be filled with 0xFF if image is saved as *.bin file) 0x1000 - 0x13FF Data of File1.bin</p> <p>Can be saved in new data file (File3.bin).</p>
Save data file	Saves the data file that currently has focus.
Save data file as...	Saves the data file that currently has focus using the name and location given.
New project	Creates a new project (See <i>Creating a new J-Flash project</i> )
Open project	Opens a J-Flash project file. Please note that only one project file may be open at a time. Opening a project will close any other project currently open.
Save project	Saves a J-Flash project file.
Save project as...	Saves a J-Flash project file using the name and location given.
Close project	Closes a J-Flash project file.
Save Flasher config file...	Saves a .CFG file for stand-alone mode using the name and location given. Please refer to the Flasher documentation (UM08022) for more information regarding stand-alone mode.
Save Flasher data file...	Saves a .DAT file for stand-alone mode using the name and location given. Please refer to the Flasher documentation (UM08022) for more information regarding stand-alone mode.
Download config & data file to Flasher	Prepares a connected Flasher for stand-alone mode using the current project and the data file which had focus most recently. Please refer to the Flasher documentation (UM08022) for more information regarding stand-alone mode.
Download serial number file to Flasher	Downloads a serial number file to a connected Flasher. Please refer to the Flasher documentation (UM08022) for more information regarding stand-alone mode.
Recent Files	Contains a list of the most recently open data files.
Recent Projects	Contains a list of the most recently open project files.
Exit	Exits the J-Flash application.

## Edit menu elements

Command...	Description
Relocate...	Relocates the start of the data file to the supplied hex offset from the current start location.
Delete range...	Deletes a range of values from the data file, starting and ending at given addresses. The End address must be greater than the Start address otherwise nothing will be done.
Eliminate blank areas...	Eliminates blank regions within the data file.

## View menu elements

Command	Description
Log	Opens and/or sets the focus to the log window.
Project	Opens and/or sets the focus to the project window.

## Target menu elements

Command	Description
Connect	Creates a connection through the Flasher using the configuration options set in the Project settings... of the Options dropdown menu.
Disconnect	Disconnects a current connection that has been made through the Flasher.
Test > Generate test data	Generates data which can be used to test if the flash can be programmed correctly. The size of the generated data file can be defined.
Test > Test speed	Writes data of an specified size to an defined address, reads the written data back and measures the up- and download speed.
Test > Show CFI info	Reads the CFI query information of a CFI compliant flash device.
Test > Hardware > Activate BUSY	Sets the RS232 Busy signal of a connected Flasher. Can be used to test the RS232 setup.
Test > Hardware > Deactivate BUSY	Resets the RS232 Busy signal of a connected Flasher. Can be used to test the RS232 setup.
Test > Hardware > Activate OK	Sets the RS232 OK signal of a connected Flasher. Can be used to test the RS232 setup.
Test > Hardware > Deactivate OK	Resets the RS232 OK signal of a connected Flasher. Can be used to test the RS232 setup.
Production Programming	Performs a sequence of steps, which can be configured in the Production tab of the Project settings. Additionally, the first step executed are the init steps and the last step executed are the exit steps, which both can be configured in the MCU tab of the project settings.
Manual Programming > Secure Chip	Secures the MCU.
Manual Programming > Unsecure Chip	Unsecures the MCU.
Manual Programming > Check Blank	Checks flash to see if it is empty.

Command	Description
Manual Programming > Erase Sectors	Erases all selected flash sectors.
Manual Programming > Erase Chip	Erases the entire chip.
Manual Programming > Program	Programs the chip using the currently active data file. Please note that no erase / blank check is performed prior programming so the flash is assumed to be in an erased state.
Manual Programming > Program & Verify	Programs the chip using the currently active data file and then verifies that it was written successfully.
Manual Programming > Verify	Verifies the data found on the chip with the data file.
Manual Programming > Read back > Selected Sectors	Reads back the data found in the selected sectors and creates a new data file to store this information.
Manual Programming > Read back > Entire chip	Reads back the data found on the chip and creates a new data file to store this information.
Manual Programming > Read back > Range	Reads back the data found in a range specified by the user and creates a new data file to store this information.
Manual Programming > Start Application	Starts the application.

### Options menu elements

Command	Description
Project settings...	Opens the project settings dialog.
Global settings...	Opens the global settings dialog.

### Window menu elements

Command	Description
Cascade	Arranges all open windows, one above the other, with the active window at the top
Tile Horizontal	Tiles the windows horizontally with the active window at the top.
Tile Vertical	Tiles the windows vertically with the active window at the left.
<List of currently open windows>	A entry of the list can be selected to move the focus to the respective window.

### Help menu elements

Command	Description
J-Flash User Guide	Opens this document in the default .PDF application of the system.
J-Link User Guide	Opens the J-Link Manual (UM08001) in the default .PDF application of the system.
Licenses...	Shows a dialog with licensing information. The serial number of a connected J-Link may be read and licenses added or removed.
About...	J-Flash and company information.

# Chapter 4

## Settings

---

The following chapter provides an overview of the program settings. Both general and per project settings are considered.

## 4.1 Project Settings

Project settings are available from the Options menu in the main window or by using the ALT-F7 keyboard shortcut.

### 4.1.1 General Settings

This dialog is used to choose the connection to Flasher. The Flasher can either be connected directly over USB to the host system of J-Flash, or it can be connected through the J-Link Remote Server running on a remote system. Refer to the J-Link Manual (UM08001) for more information regarding the operation of Flasher and J-Link Remote Server. Select the Engineering checkbox when setting up a project or the Simplified checkbox when using J-Flash in production environments. In the simplified user interface some options are disabled to decrease possible error sources in the production phase.

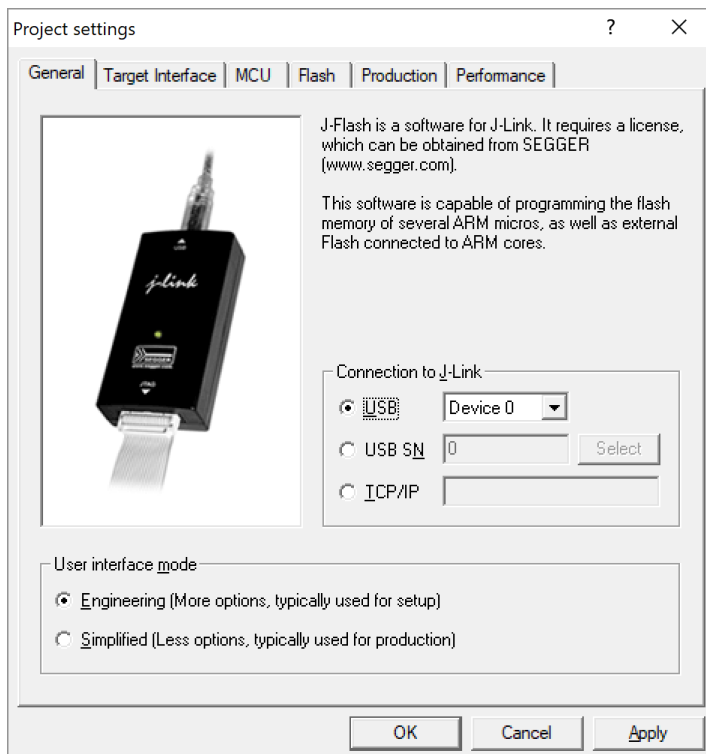

*General Settings*

#### USB

If this option is checked, J-Flash will connect to Flasher over the USB port. The default device number is 0. For more information about how to use multiple Flasher on one PC, please see also the chapter "Working with J-Link" of the J-Link Manual (UM08001).

#### USB S/N

If this option is checked, J-Flash will connect to Flasher over the USB port. J-Flash will only use the Flasher with the specified S/N and any operation will fail if the Flasher with specified S/N is not connected or cannot be used for any reason.

#### TCP/IP

If this option is checked, J-Flash will connect to Flasher via J-Link Remote Server. The hostname of the remote system running the J-Link Remote Server must be specified.

### 4.1.2 Target Interface Settings

This dialog is used to configure the interface connection to the target.

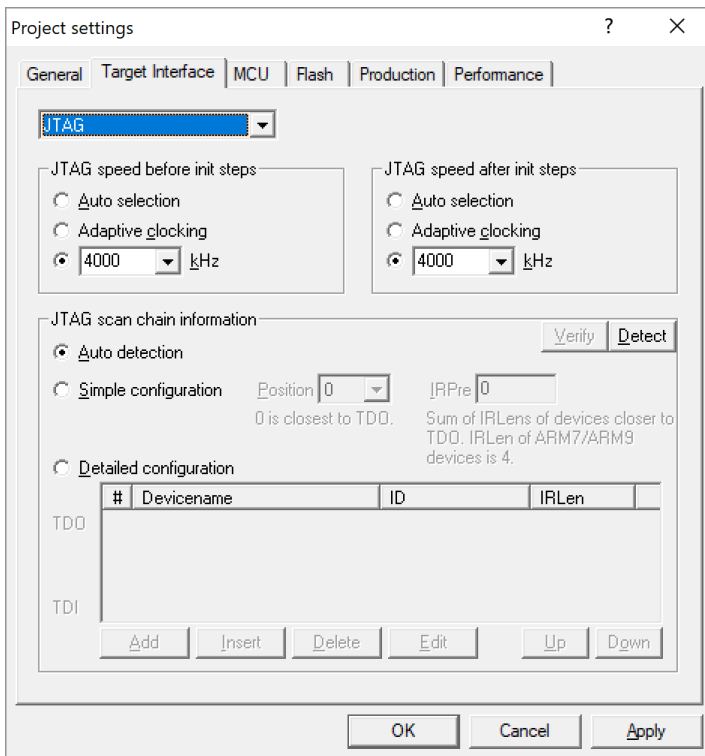

Target Interface Settings

### 4.1.2.1 Interface Speed

The interface speed used before and after initialization can be configured. The interface speed before init is used to communicate with the target before and during execution of the custom initialization sequence (described in the section *Init steps* on page 32). The interface speed after init is used to communicate after executing the custom initialization sequence. This is useful if a target running at slow speed and the users wants to set up a PLL in the initialization sequence.

For more information about the different types of interface speed please see the chapter "Setup" of the J-Link Manual (UM08001).

### 4.1.2.2 JTAG scan chain with multiple devices

This checkbox allows to configure a JTAG scan chain with multiple devices on it. In a scan chain configuration with multiple devices, the TCK and TMS lines of all JTAG devices are connected, while the TDI and TDO lines form a ring.

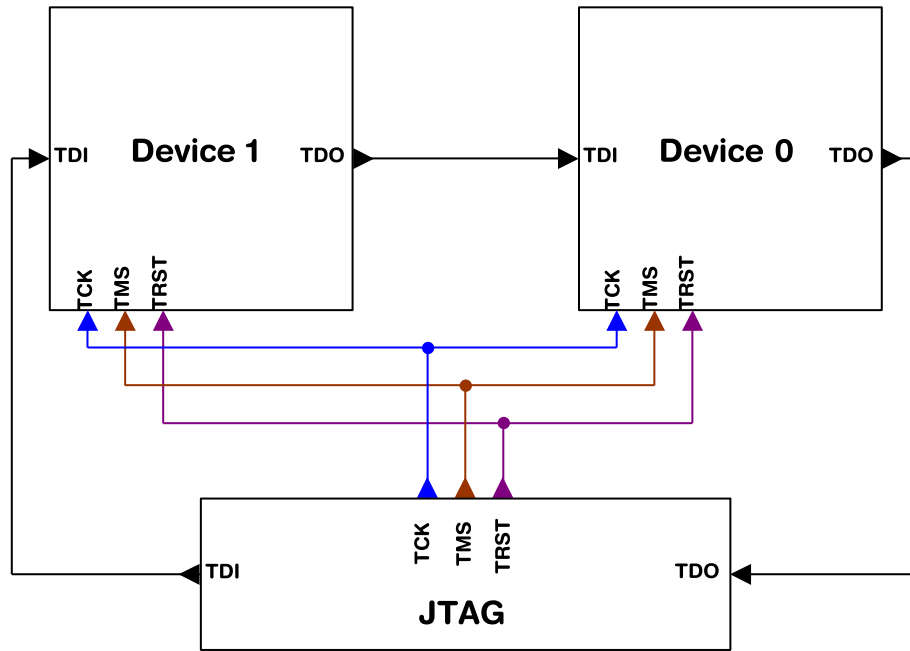

### JTAG-chain

The position of the device to connect with J-Flash is selected from the Position dropdown menu. The Instruction Register length (IRLen) of a device is defined by its manufacturer. For ARM cores, the IRLen is always four, which is why the value of IRLen is by default set to four times the position indicated. This works fine for ARM only scan chains. However, if any non-ARM devices are introduced to the scan chain the IRLen must be modified accordingly.

## 4.1.3 MCU Settings

This dialog allows the selection of microcontroller dependent settings.

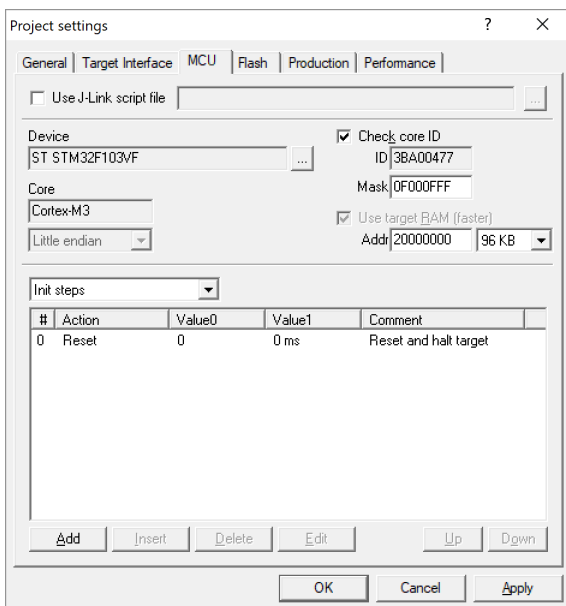

### MCU Settings

J-Flash can be used to program both external or internal flash memory. In order to use J-Flash with an external flash device, the proper **Core** must be selected.

To program internal flash devices choose the respective microcontroller in the **Device** list. If a microcontroller is not found on this list, contact SEGGER, as new microcontrollers are continuously being added.

### Device

Select the respective microcontroller from the list to program internal flash devices. In order to program external flash, select the device or core from the list.

### Clock speed

For some devices, the actual CPU clock frequency in Hz of the MCU is required to guarantee accurate operation of J-Flash. By default, J-Flash uses the "Auto" CPU speed detection feature.

### Endianness

The compatible endianness of the selected device is set automatically if possible. Otherwise, select **little endian** or **big endian** from dropdown menu accordant to the device.

## 4.1.3.1 Check core ID

If the core ID is known for the device to be programmed, it can be used to verify that the device in communication via the Flasher is the intended device. The core ID for all listed devices is known, therefore this value is filled in automatically if a device is selected and can not be modified. If only a core family is selected, the core **ID** field can be modified.

### Mask

This option allows the user to mask out specified bits of the core ID. All bits set to 0 in "Mask" are not taken into account when comparing the Code ID found by Flasher with the Core ID entered in J-Flash.

Example:

Values	Check result
Core ID entered: 0x3BA00477 Core ID found: 0x4BA00477 Mask: 0xFFFFFFFF	Failed
Core ID entered: 0x3BA00477 Core ID found: 0x4BA00477 Mask: 0x0FFFFFFFF	Passed

The code ID check works as follows:

```
CoreIDFound &= Mask;
CoreIDEntered &= Mask;
if (CoreIDFound != CoreIDEntered) {
    return Error; // Core ID check failed.
}
```

## 4.1.3.2 Use target RAM

The target RAM is used during flash programming to store the RAMCode. This RAM is called work RAM. Defines the start address and the size size of the work RAM.

## 4.1.3.3 Init steps

Many microcontrollers require an initialization sequence for different reasons: When powered on, the PLL may not be initialized, which means the chip is very slow, or a watchdog must be disabled manually. To use these chips the user must first perform the required initialization.



This dialog allows the user to enter a custom initialization sequence using a predefined list of operations. After choosing an operation and corresponding values to be associated with the operation, a comment may be added to make it easier for others to determine its effect. The following list shows all valid commands which can be used in an init sequence:

Command	Value0	Value1	Description
Delay	-	Length of the delay	Sets a delay.
DisableMMU	-	-	Disables the MMU.
Disable Checks	-	-	Disables JTAG checks. Some CPUs (e.g. TMS470R1B1M) report JTAG communication errors while initializing, so that they can not be programmed if the JTAG communication checks are enabled.
Enable Checks	-	-	Enables JTAG checks. This option is activated by default.
Go	-	-	Starts the CPU
Halt	-	-	Halts the CPU
Reset	J-Link reset type	Length of the delay	Resets the CPU. Refer to the J-Link Manual (UM08001) for an detailed explanation of the different reset types.
Read 8bit	Address (Hex)	-	Reads 8bit from a given address and stores the value in the internal variable.
Read 16bit	Address (Hex)	-	Reads 16bit from a given address and stores the value in the internal variable.
Read 32bit	Address (Hex)	-	Reads 32bit from a given address and stores the value in the internal variable.
SetAllowRemoteRead	-	On/Off	This option defines if the emulator (remote) or the host handles the read access to the target. This option is activated by default to enhance the performance.
SetAllowRemoteWrite	-	On/Off	This option defines if the emulator (remote) or the host handles the write access to the target. This option is activated by default to enhance the performance.
Verify 8bit	Address (Hex)	Data (Hex)	Verifies whether 8bit data on a declared address is identical to the declared 8bit data.
Verify 16bit	Address (Hex)	Data (Hex)	Verifies whether 16bit data on a declared address is identical to the declared 16bit data.
Verify 32bit	Address (Hex)	Data (Hex)	Verifies whether 32bit data on a declared address is identical to the declared 32bit data.
Write 8bit	Address (Hex)	Data (Hex)	Writes 8bit data to a given address.
Write 16bit	Address (Hex)	Data (Hex)	Writes 16bit data to a given address.

Command	Value0	Value1	Description
Write 32bit	Address (Hex)	Data (Hex)	Writes 32bit data to a given address.
Write&Verify 8bit	Address (Hex)	Data (Hex)	Writes 8bit data to a given address and verifies it afterwards.
Write&Verify 16bit	Address (Hex)	Data (Hex)	Writes 16bit data to a given address and verifies it afterwards.
Write&Verify 32bit	Address (Hex)	Data (Hex)	Writes 32bit data to a given address and verifies it afterwards.
Write Register	Register	Data (Hex)	Writes data into a register.
Write JTAG IR	Command	–	Writes a command in the JTAG instruction register.
Write JTAG DR	NumBits	Data (Hex)	Writes a declared number of bits into the JTAG data register.
Var AND	–	Value (Hex)	Logical AND combination of the internal variable with a given value.
Var OR	–	Value (Hex)	Logical OR combination of the internal variable with a given value.
Var XOR	–	Value (Hex)	Logical XOR combination of the internal variable with a given value.
Var BEQ	Index	–	Checks if the internal variable is equal to 0. Performs jump to index on match.
Var BNE	Index	–	Checks if the internal variable is not equal to 0. Performs jump to index on match.
Var Write 8bit	Address (Hex)	Data (Hex)	Writes 8bit data of the internal variable to a given address.
Var Write 16bit	Address (Hex)	Data (Hex)	Writes 16bit data of the internal variable to a given address.
Var Write 32bit	Address (Hex)	Data (Hex)	Writes 32bit data of the internal variable to a given address.
SetModeBigEndian	–	–	Sets bit 7 of the CP15 register to 1.
SetModeLittleEndian	–	–	Sets bit 7 of the CP15 register to 0.
Var Write File 8bit	Address (Hex)	–	Writes 8bit data of the internal variable to a given address in the data file.
Var Write File 16bit	Address (Hex)	–	Writes 16bit data of the internal variable to a given address in the data file.
Var Write File 32bit	Address (Hex)	–	Writes 32bit data of the internal variable to a given address in the data file.
Comment	–	–	Can be used as additional space to insert comments. Does nothing.
Write File 8bit	Address (Hex)	Data (Hex)	Writes 8bit data to a given address in the data file.
Write File 16bit	Address (Hex)	Data (Hex)	Writes 16bit data to a given address in the data file.

Command	Value0	Value1	Description
Write File 32bit	Address (Hex)	Data (Hex)	Writes 32bit data to a given address in the data file.

### Note

All "Write \*" commands may only be used to write RAM or SFR registers, but not Flash memory. Flash memory can only be influenced by altering the data file. The data file can be changed in the init steps by using the "Write File\*" commands.

### 4.1.3.4 Exit steps

Those steps will be performed immediately after the target has been successfully programmed. In case of verify is checked in the production settings (**Options** -> **Project settings...** -> **Production settings tab**), those steps will be performed after verify.

The Exit steps can be used to do some special handling after programming, for example to set some security bits in order to secure the chip.

### Note

Exit steps are only performed for "Target->Production Programming" operations.

## 4.1.4 Flash Settings

This dialog is used to select and configure the flash device to operate with. The listed options of the Flash settings menu are dependent on the selection in the *MCU Settings* on page 31. If a core family has been selected in order to program external flash memory or a custom Flash Bank has been added and is selected, the menu should look similar to the screenshot below.

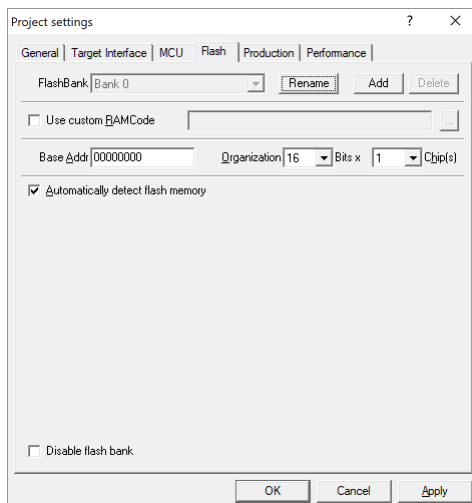

### Flash Settings: external Flash

If a specific device has been selected to program the flash of these device, the menu should look similar to the screenshot below.

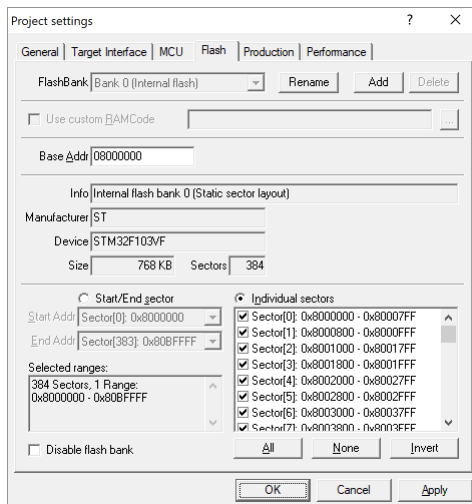

Flash Settings: internal Flash

#### 4.1.4.1 Base Address

This is the base address of the flash.

#### 4.1.4.2 Sector selection

The final section of this dialog indicates the sectors to be acted upon, whether they are to be cleared, read back, or written. An individual or series of sectors may be selected from the predetermined valid range.

#### 4.1.4.3 Disable flash bank

The **Disable flash bank** checkbox disables the flash bank currently selected in the drop-down menu, which can be used to change which flash banks are processed by J-Flash with only one click per flash bank. This is especially useful when testing different configurations.

#### 4.1.4.4 External Flash specific settings

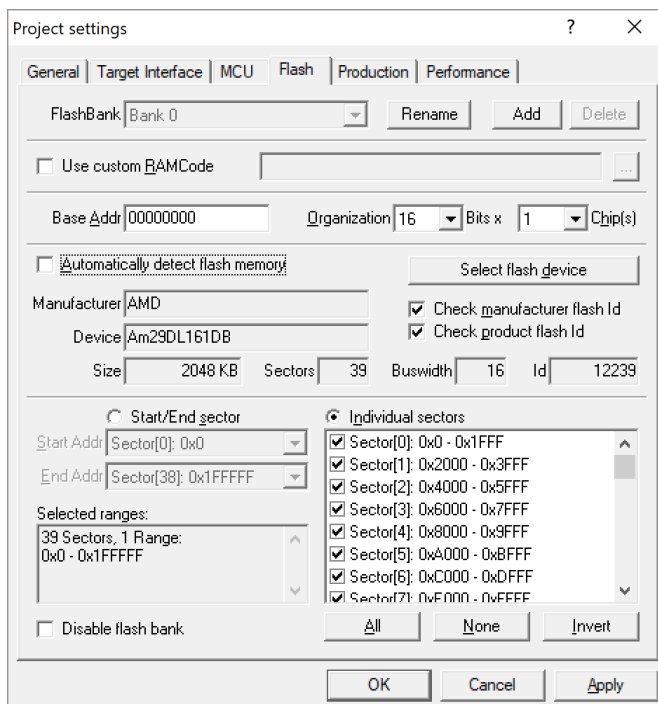

Flash Settings: external Flash, auto detection unchecked

## Organization

For some flashes (e.g. CFI compliant NOR flashes), the organization needs to be specified. Configures the bus width and the number of flash chips connected to the address and data bus of the MCU.

## Select flash device

The flash device can be selected manually or the J-Flash Auto Detection feature can be used. The auto detection feature is select by default. It supports both CFI compliant flash memory chips and non CFI compliant chips. A flash device can be selected manually, if the Auto Detection checkbox is deselected and the Select flash device button is clicked.

After invoking this button a table will be presented. The table may be filtered using the manufacturer name. The chip and its attributes (manufacturer name, device name, size, number of sectors, eight bit identifier, sixteen bit identifier, bus width) must be selected from this table. If the flash chip is not found please contact SEGGER, as devices are continuously being added to this list.

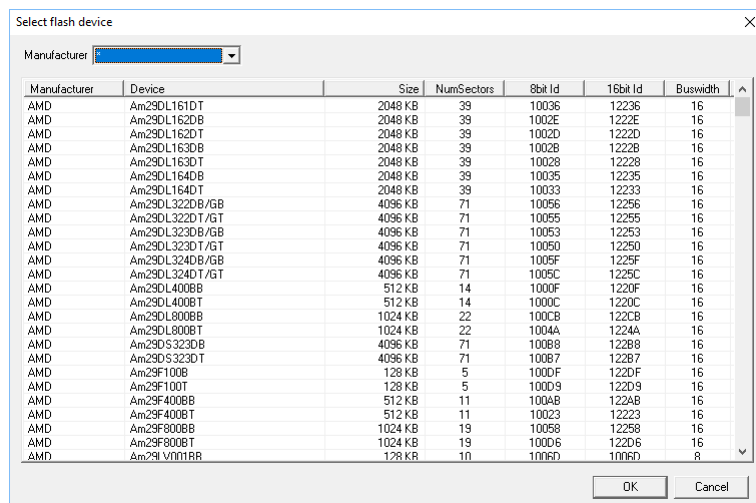

Flash device Selection Dialog

## ID checking

There are two other checkboxes that are of interest in this subsection which are "Check manufacturer flash Id" and "Check product flash Id". These checkboxes should be selected to confirm the type of device that is in communication with J-Flash.

## 4.1.5 Production settings

### Production Settings

#### Target power supply

Available power source options are:

- None
- $V_{CC5V}$
- $V_{TGT}$

*Delay before start* defines the delay (in ms) after enabling the target power supply and before starting to communicate with the target.

*Discharge target on disconnect* causes a discharge of any capacities left on the target on disconnect.

#### Note

The option "Power source  $V_{TGT}$ " is for Flasher ATE only. The other Flasher models will use the  $V_{CC5V}$  option if not chosen NONE.

#### Note

The option "Discharge target" is for Flasher ATE only and will be ignored by the other Flasher models.

#### Reference voltage settings

Enabling VTref monitor causes the Flasher to monitor the target voltage ( $V_{Tref}$ ) in stand-alone mode and makes the Flasher throw an error when the voltage drops below the minimum or rises above the maximum during programming.

#### Program serial number

J-Flash supports programming of serial numbers into the target in two ways. For a detailed description how to use the serial number programming feature please refer to *Serial number programming* on page 21

## Actions performed by "Auto"

The checked options will be performed when auto programming a target (**Target -> Production Programming**, shortcut: F7). The default behavior is

- Init Steps (is always the first step)
- Erase sectors if not blank
- Program
- Verify via CRC.
- Exit Steps (is always the last step)

Steps not enabled per default:

- Start application
- Secure chip

Find below a table which describes the commands:

Command	Description
Init steps	Executes the init steps defined in the MCU settings
Erase sectors	Performs an erase depending on the settings, selected in the drop down box. <ul style="list-style-type: none"> <li>• Sectors: Erases all sectors which are effected by the image to be programmed.</li> <li>• Sectors if not blank: Erases all sectors which are both, effected by the image to be programmed and not already blank</li> <li>• Chip: Erase the entire chip independent of the content.</li> </ul>
Program	Programs the data file.
Verify	Verifies the program data. <ul style="list-style-type: none"> <li>• CRC: Verifies data via a high optimized CRC calculation (recommended verification method).</li> <li>• Complete data: Verifies data by reading it back.</li> </ul>
Start application	Starts application after programming/verify completed. Needs reset pin to be connected to Flasher.
Secure chip	Secures the device if supported by algorithm.
Exit steps	Executes the exit steps defined in the MCU settings

## 4.1.6 Performance settings

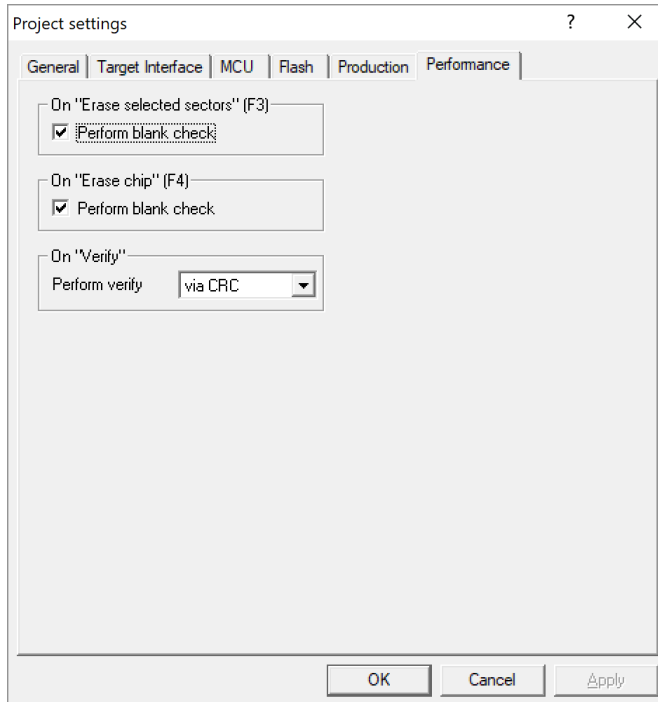

### *Performance Settings*

#### **On "Erase selected sectors" / On "Erase chip"**

If "Perform blank check" is checked, a blank check will be performed before an erase. If the area to erase is already blank, no erase happens.

#### **Note**

This check takes place for Target > Production Programming as well as Target > Manual Programming.

#### **On "Verify"**

Configures the type of verify that takes place.



## 4.2 Global Settings

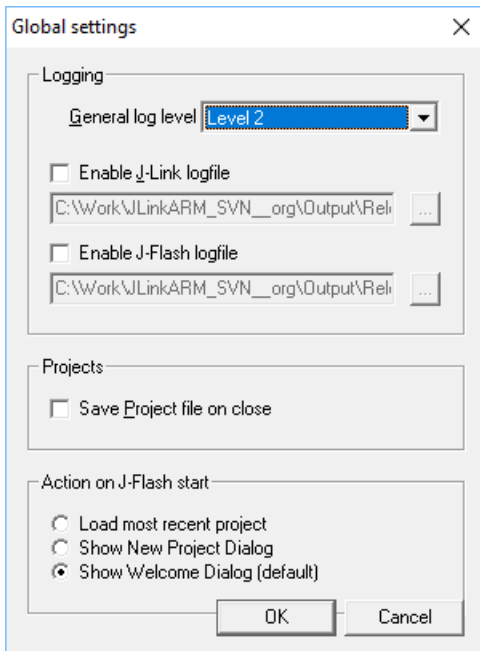

### *Global Settings*

Global settings are available from the Options menu in the main window.

### **General log level**

This specifies the log level of J-Flash. Increasing log levels result in more information logged in the log window.

### **Enable J-Link logfile**

If this option is checked, a file name of the J-Link logfile can be specified. The J-Link logfile differs from the log window output of J-Flash. It does not log J-Flash operations performed. Instead of that, it logs the J-Link DLL API functions called from within J-Flash.

### **Enable J-Flash logfile**

If this option is checked, a file name of the J-Flash logfile can be specified. The J-Flash logfile contains the same messages as the log window output of J-Flash.

### **Save project file on close**

If this option is checked, J-Flash will always save the changes made to a project file when a project or J-Flash is closed and therefore overrides the old project file without asking for permission to do so.

### **Action on J-Flash start**

In this section, the action J-Flash performs on startup can be selected.

# Chapter 5

## Command Line Interface

---

This chapter describes the J-Flash command line interface. The command line allows using J-Flash in batch processing mode and other advanced uses.

## 5.1 Overview

In addition to its traditional Windows graphical user interface (GUI), J-Flash supports a command line mode as well. This makes it possible to use J-Flash for batch processing purposes. All important options accessible from the menus are available in command line mode as well. If command line options are provided, J-Flash will still start its GUI, but processing will start immediately.

The screenshot below shows the command line help dialog, which is displayed if J-Flash is started in a console window with *JFlash.exe -help* or *JFlash.exe -?*



Command line options

## 5.2 Command line options

This section lists and describes all available command line options. Some options accept additional parameters which are enclosed in angle brackets, e.g. <FILENAME>. If these parameters are optional they are enclosed in square brackets too, e.g. [<SADDR>]. Neither the angle nor the square brackets must be typed on the command line, they are used here only to denote (optional) parameters. Also, note that a parameter must follow immediately after the option, e.g. JFlash.exe -openprjC:\Projects\Default.jflash.

The command line options are evaluated in the order as they are passed to J-Flash, so please ensure that a project + data file have already been opened when evaluating a command line option which requires this.

It is recommended to always use `-open<FILENAME>[,<SADDR>]` to make sure the right data file is opened. All command line options return 0 if the processing was successfully. A return value unequal 0 means that an error occurred.

Option	Description
-?	Displays the help dialog.
-auto	Executes the steps selected in Production Programming. Default: Erases, programs and verifies target.
-checkblank	Blank checks target.
-connect	Connects to the target.
-delrange<SADDR>,<EADDR>	Deletes data in the given range.
-disconnect	Disconnects from the target.
-download	Downloads configuration to emulator.
-eliminate	Eliminates blank areas in data file.
-erasechip	Erases the entire flash chip.
-erasesectors	Erases selected sectors.
-exit	Exits J-Flash.
-help	Displays the help dialog.
-jflashlog<FILENAME>	Sets a temporary J-Flash logfile.
-jlinklog<FILENAME>	Sets a temporary J-Link logfile.
<ul style="list-style-type: none"> <li>• -merge&lt;FILENAME&gt;</li> <li>• -merge&lt;FILENAME&gt;.bin,&lt;ADDR&gt;</li> </ul>	Merges a given data file with the one currently opened in J-Flash.
-min	Starts J-Flash minimized
-open<FILENAME>[,<SADDR>]	Opens a data file
-openprj<FILENAME>	Opens an existing project file. This will also automatically open the data file that has been recently used with this project.
-production	Same as -auto
-program	Programs the target.
-programverify	Programs and verify the target.
-readchip	Reads the entire flash chip.
-readsectors	Reads selected sectors.
-readrange<SADDR>,<EADDR>	Reads specified range of target memory.
-relocate<OFFSET>	Relocates data by the given offset.
-save[<SADDR>,<EADDR>]	Saves the current data file. Please note that the parameters <SADDR>,<EADDR> apply only if the data file is a *.bin file or *.c file.

Option	Description
-saveas<FILENAME>[,<SAD-DR>,<EADDR>]	Saves the current data file in the specified file. Please note that the parameters <SAD-DR>,<EADDR> apply only if the data file is a *.bin file or *.c file.
-savecfg<FILENAME>	Saves emulator config file.
-savedat<FILENAME>	Saves emulator data file.
-saveprj	Saves the current project.
-saveprjas<FILENAME>	Saves the current project in the specified file.
-securechip	Secures target device.
-setcpuidcode<IDCodeString>	Sets the CPU ID code to be used by the DLL (e.g. during authentication process).
-setrxidcode<IDCodeString>	Sets the RXIDCode to be used by the DLL. Additional info <IDCodeString>: 32 characters, 16 IDCode bytes
-startapp	Starts the target application.
-unsecurechip	Unsecures target device.
-verify	Verifies the target memory.
-usb<SN>	Overrides connection settings to USB S/N.
<ul style="list-style-type: none"> <li>• -ip&lt;xxx.xxx.xxx.xxx&gt;</li> <li>• -ip&lt;HostName&gt;</li> </ul>	Overrides connection settings to IP.
-hide	Starts J-Flash hidden.

## 5.3 Batch processing

J-Flash can be used for batch processing purposes. All important options are available in command line mode as well. If command line options are provided, J-Flash will still start its GUI, but processing will start immediately.

The example batchfile below will cause J-Flash to perform the following operations:

1. Open project C:\Projects\Default.jflash
2. Open bin file C:\Data\data.bin and set start address to 0x100000
3. Perform "Auto" operation in J-Flash (by default this performs erase, program, verify)
4. Close J-Flash

The return value will be checked and in case of an error an error message displayed. Adapt the example according to the requirements of your project.

```
@ECHO OFF

ECHO Open a project and data file, start auto processing and exit
JFlash.exe -openprjC:\Projects\Default.jflash -openC:\Data
\data.bin,0x100000 -auto -exit
IF ERRORLEVEL 1 goto ERROR

goto END

:ERROR
ECHO J-Flash ARM: Error!
pause

:END
```

### Starting J-Flash minimized

Adapt this example call to start J-Flash minimized:

```
start /min /wait "J-Flash" "JFlash.exe" -openprjC:\Projects\Default.jflash \
-openC:\Data\data.bin,0x100000 -auto -exit
```

#### Note

that every call of `JFlash.exe` has to be completed with the `-exit` option, otherwise the execution of the batch file stops and the following commands will not be processed.

## 5.4 Programming multiple targets in parallel

In order to program multiple targets in parallel using J-Flash, the following is needed:

- J-Link / Flasher needs to be configured to allow to connect multiple ones to one PC at the same time. Please refer to "UM08001 Working with J-Link and J-Trace" -> "Connecting multiple J-Links / J-Traces to your PC"
- One J-Flash project (containing the configuration).

Basically, J-Flash connects to a specific Flasher, configured in the project settings, but there is a command line option available, which allows to temporary override this setting. Therefore, only one J-Flash project is needed.

Find below a small sample which shows how to program multiple targets in parallel.

```
@ECHO OFF
setlocal
set "lock=%temp%\wait%random%.lock"

ECHO Launches 3 processes in parallel, where each process calls J-Flash with different serial nu
The stream of each process is redirected to a lock file so we can wait until each process has be
start "" 9>"%lock%1" StartJFlash.bat 164000000
start "" 9>"%lock%2" StartJFlash.bat 164000001
start "" 9>"%lock%3" StartJFlash.bat 164000002
REM Wait until lock files are released and delete them afterwards
1>nul 2>nul ping /n 3 ::1
for %%N in (1 2 3) do (
(call ) 9>"%lock%%N" || goto :Wait
) 2>nul
del "%lock%*"
pause
```

StartFlash.bat:

```
@ECHO OFF
ECHO Open a project and data file and exit
start /wait "J-Flash" "JFlash.exe" -usb%1 -connect -exit
IF ERRORLEVEL 1 goto ERROR
goto END
:ERROR
ECHO %ERRORLEVEL%
ECHO J-Flash: Error! SN: %1
pause
exit
:END
ECHO J-Flash: Succeed!
exit
```

# Chapter 6

## Device specifics

---

For some devices, special handling might be required. In order to find out if special handling is necessary for the used device, please refer to the SEGGER wiki: [SEGGER Wiki: Device specifics](#)



# Chapter 7

## Target systems

---

The following chapter lists all supported flash devices.

## 7.1 Which devices can be programmed by J-Flash?

J-Flash supports programming of internal and external flash devices. The external flash device can be:

- Parallel NOR flash
- Serial NOR flash
- NAND flash
- DataFlash

For parallel NOR flash any combination of ARM CPU and parallel NOR flash device (1x8bit, 2x8bit, 4x8bit, 1x16bit, 2x16bit, 1x32bit) is supported, if the NOR flash device is CFI-compliant. If the NOR flash device which is used is not CFI-compliant, the flash device has to explicitly selected in J-Flash. For a list of all parallel NOR flash devices which can be explicitly selected in J-Flash, please refer to *Supported Flash Devices* on page 51.

For serial NOR flash, NAND flash and DataFlash devices a custom RAMCode is needed since the connection of the flash to the CPU differs from device to device.

For more information about which which microcontrollers with internal flash are supported by J-Flash, please refer to *Supported microcontrollers* on page 51.

SEGGER is constantly adding support for new devices. If you need support for a chip or flash not listed in the tables, do not hesitate to contact us.

## 7.2 Supported microcontrollers

J-Flash supports download into the internal flash of a large number of microcontrollers. The latest list of supported devices can always be found on our website:

*[List of supported devices](#)*

### 7.2.1 Supported Flash Devices

J-Flash supports a large number of external parallel NOR flash devices. In general, every CFI-compliant parallel NOR flash device is supported by J-Flash. For non-CFI compliant ones, J-Flash allows the user to explicitly select the device. The latest list of supported flash devices can always be found on our website:

*[List of supported flash devices](#)*

# Chapter 8

## Performance

---

For programming speed measurements, please refer to the SEGGER website: [Internal Flash programming performance](#)

# Chapter 9

## Background information

---

This chapter provides some background information about specific parts of the J-Flash software.

# 9.1 CRC of current data file

When opening a data file in J-Flash (**File -> Open...**), J-Flash calculates and displays the CRC of the user data in this file.

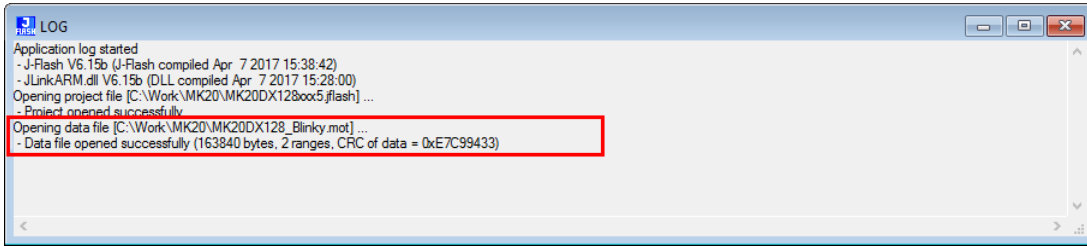

### CRC in Log Window

The following steps are taken into consideration when calculating this CRC:

1. The CRC is calculated over all sectors which are selected in the current project

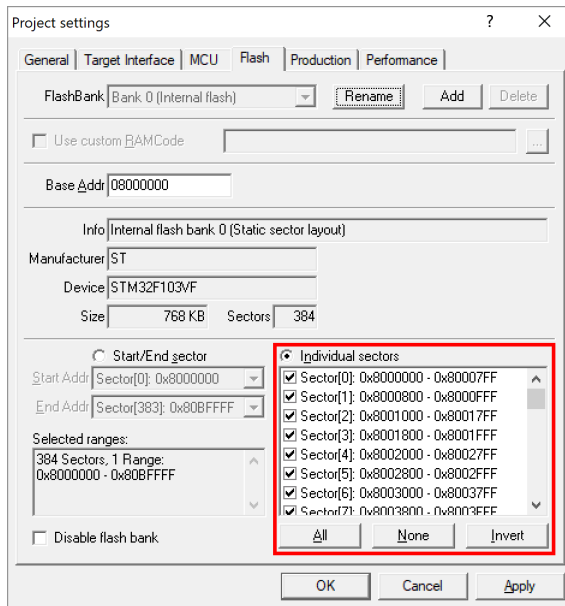

### CRC: selected sectors

2. Everything that is not covered by the data file (gaps in the data file, unused sectors etc.) which is opened, is assumed as 0xFF during the CRC calculation.
2. The polynomial which is used for the CRC calculation is 0xEDB88320.

# Chapter 10

## Support

---

The following chapter provides information about how to contact our support.

## 10.1 Troubleshooting

### 10.1.1 General procedure

- Make sure the J-Link / Flasher is working as expected. See the troubleshooting article in the SEGGER wiki: [LINK](#)
- Ensure that the target hardware matches the project file settings. Pay special attention to the following aspects:
  - Init sequence
  - Clock speed
  - RAM address
  - Flash base address
  - MCU / Flash chip
  - Flash organization
- The interface clock frequency depends on several factors, e.g. cable length, target board etc. Try setting the frequency to lower or higher values accordingly.
- Make sure the flash memory is unlocked before programming or erasing.

### 10.1.2 Typical problems

#### **Failed to connect**

*Meaning:*

This error message is shown if any error occurs during the connection process.

*Remedy:*

First of all, make sure the target is actually connected to J-Link. Verify the correctness of the init sequence, check the JTAG speed, and ensure the correct flash type is selected.

#### **Programming / Erasing failed**

*Meaning:*

The flash memory sector may be locked and programming or erasing the respective memory section fails therefore.

*Remedy:*

Make sure the memory sector is unlocked before programming or erasing. J-Flash provides a dedicated menu item for unlocking flash memory.

#### **Timeout errors during programming**

*Meaning:*

A timeout occurs if the target is too slow during DCC communication or the target flash memory is too slow during programming.

*Remedy:*

Using smaller RAM block sizes may fix this problem.

#### **Blank check failed**

*Meaning:*

The target memory was not empty during blank check.

*Remedy:*

Erase target memory.

#### **RAM check failed**

*Meaning:*



No RAM found at the specified RAM location.

*Remedy:*

Make sure a correct RAM address is specified in the project settings. See section MCU Settings.

### **Unexpected core ID**

*Meaning:*

The specified CPU core ID does not match with the one read from the target CPU.

*Remedy:*

Ensure the specified core ID is correct for the used target CPU. See section MCU Settings for information about setting the core ID.

### **Unsupported flash type / bus width**

*Meaning:*

The target flash memory or the bus organization is not yet supported.

*Remedy:*

Inform us about the flash type you want to use. SEGGER is constantly adding support for new flash memory devices.

### **No matching RAMCode**

*Meaning:*

There is no programming algorithm available for the selected target memory type.

*Remedy:*

Inform us about the flash type you want to use. SEGGER is constantly adding support for new flash memory devices.

## 10.2 Contacting support

If you experience a J-Flash related problem and the advices from the sections above do not help you to solve it, you may contact our J-Flash support. In this case, please provide us with the following information:

- A detailed description of the problem.
- The relevant logfile and project file. In order to generate an expressive logfile, set the log level to "All messages" (see section Global Settings for information about changing the log level in J-Flash).
- The relevant data file as a .hex or .mot file (if possible)
- The processor and flash types used

Once we received this information we will try our best to solve the problem for you. Our contact address is as follows:

SEGGER Microcontroller GmbH

Ecolab-Allee 5  
D-40789 Monheim am Rhein

Germany

Tel.           +49-2173-99312-0  
Fax.           +49-2173-99312-28  
E-mail:       support@segger.com  
Internet:     [www.segger.com](http://www.segger.com)